

UNIVERSITY OF ILLINOIS
AT URBANA-CHAMPAIGN

Physics 403. Modern Physics Laboratory

Fall 2024
Eugene V Colla, Virginia Lorenz



illinois.edu

Physics 403 Modern Physics Laboratory

Fall 2024 Teaching Team



Eugene

Eugene V Colla

kolla@illinois.edu



Gina

Virginia Lorenz

vlorenz@illinois.edu



Irina

Irina Burkova

burkova@illinois.edu



Todd

Todd Moore

tcmoore@illinois.edu

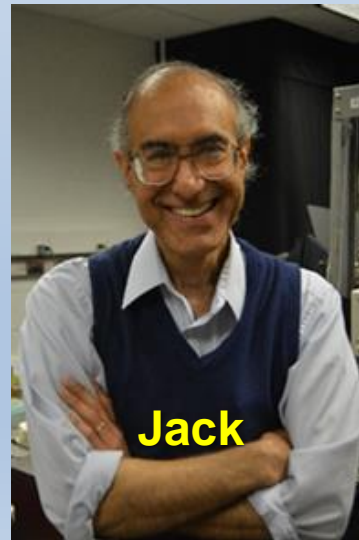

Jack

Jack Boparai

jboparai@illinois.edu



Eduard

Eduard Ilin

eduard@illinois.edu

Physics 403 Modern Physics Laboratory

Fall 2024 Teaching Team



Soroush

Soroush Hoseini
shosei2@illinois.edu



Tegan

Tegan Loveridge
tegant12@illinois.edu



Dong Beom

Dong Beom Kim
dbkim3@illinois.edu



Kelsey

Kelsey Ortiz
kcortiz2@illinois.edu



Keshav

Keshav Kapoor
keshavk@illinois.edu



Benjamin

Benjamin Nussbaum
bn9@illinois.edu



Ujaan

Ujaan Purakayastha
up2@illinois.edu



Sam

Samantha Isaac
isaac5@illinois.edu



David

David Diaz
davidd5@illinois.edu



John

John Floyd
johnf5@illinois.edu

Outline

I. Goals of the course

II. Teamwork / grades / expectations from you

III. Syllabus and schedule

IV. Your working mode

In class and “after hours” access

Safety, Responsibility

Home and away computing

V. Take a Lab tour !

VI. Let’s get started

electronic logbooks

digital scopes



Course Goals. Primary goals:

- **Learn how to “do” research**

- ✓ **Each project is a mini-research effort**

- ✓ **How are experiments actually carried out ?**

 - The procedures aren't all written out**

 - The questions are not in the back of the chapter**

 - The answers are not in the back of the book**

 - You will have to learn to guide your own activities***

- ✓ **Use of modern tools and modern analysis and data-recording techniques**



Course Goals. Primary goals:

- Learn how to document your work
 - Online - **electronic logbook ***
 - Online – saving data and projects in student area on server
 - Using traditional paper logbooks
 - Making an analysis report
 - Writing **formal reports**
 - Presenting your findings **orally**



Course Goals. Secondary goals:

- **Learn some modern physics**
 - **Many experiments were once Nobel-prize-worthy efforts**
 - **They touch on important themes in the development of modern physics**
 - **Some will provide additional insight to understand advanced courses you have taken**
 - **Some are just too new to be discussed in textbooks**



The Experiments. Three main groups

- **Nuclear / Particle (NP)**
- **Atomic / Molecular / Optics (AMO)**
- **Condensed Matter (CM)**

You will do the experiment from all these groups



The Experiments

- Nuclear / Particle (NP)
 - Alpha particle range in gasses
 - γ - γ correlation experiment
 - γ – spectroscopy
 - Mössbauer spectroscopy

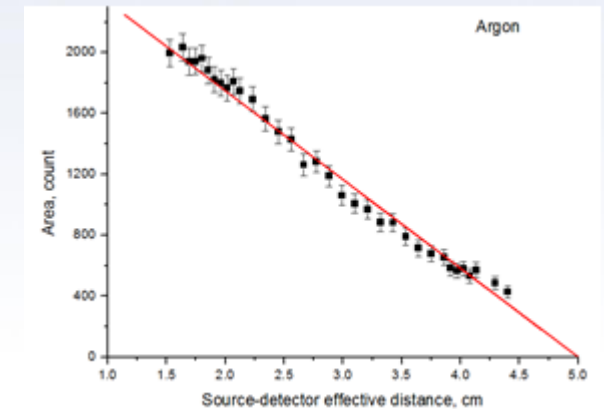
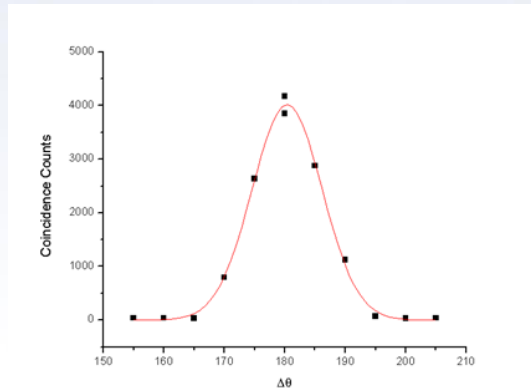
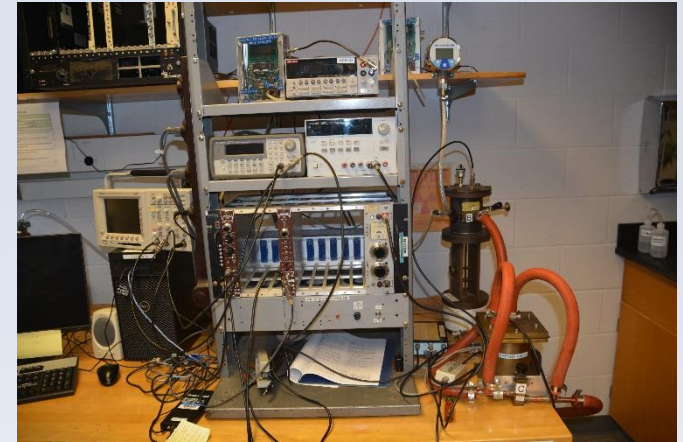

The Experiments

- Nuclear / Particle (NP)
 - Cosmic ray muons:
Lifetime, capture rate, magnetic moment
 - Angular distribution of cosmic rays
 - Mössbauer spectroscopy

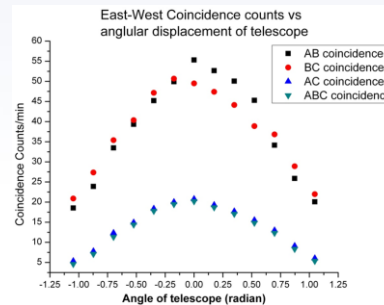
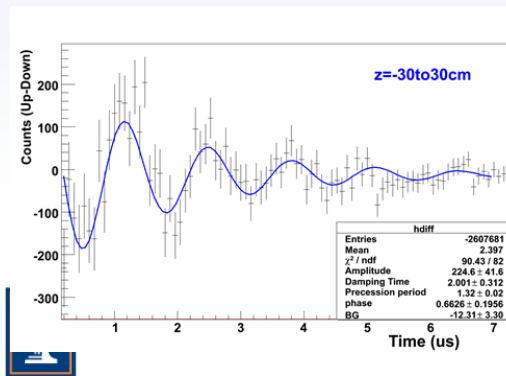

The Experiments

Atomic/Molecular/Optics (AMO)

- Berry's phase
- Quantum erasure
- Quantum Entanglement

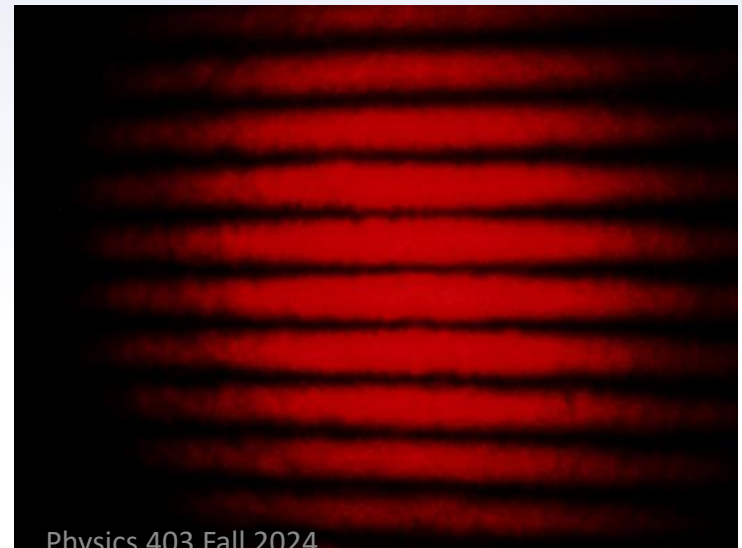
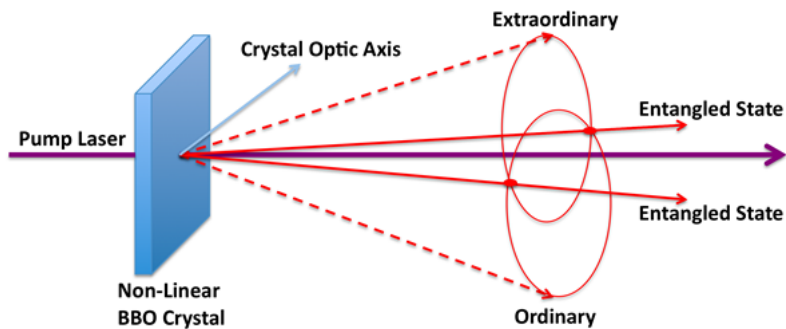
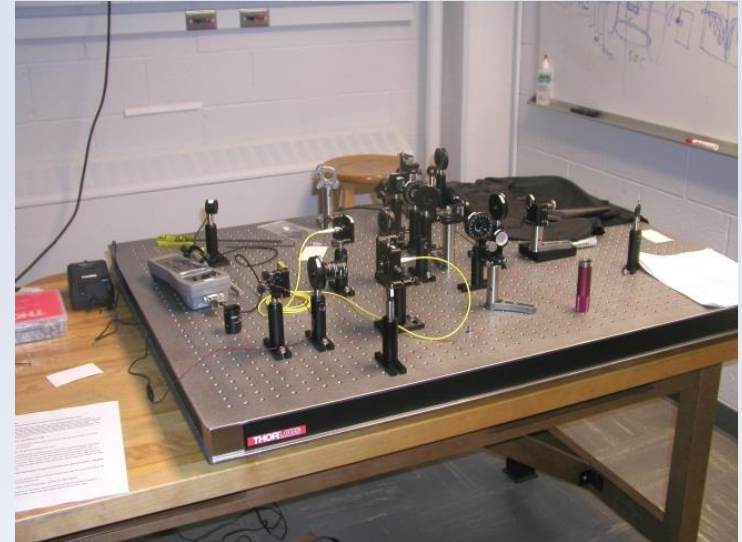

The Experiments

Atomic/Molecular/Optics (AMO)

- Optical pumping of rubidium gas
- Fluorescence spectroscopy

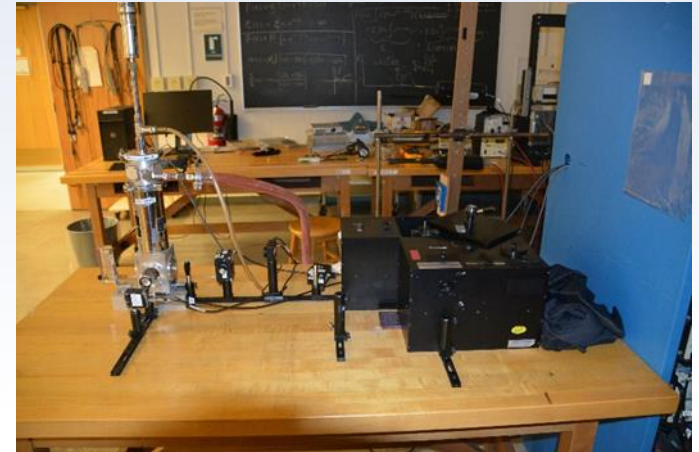
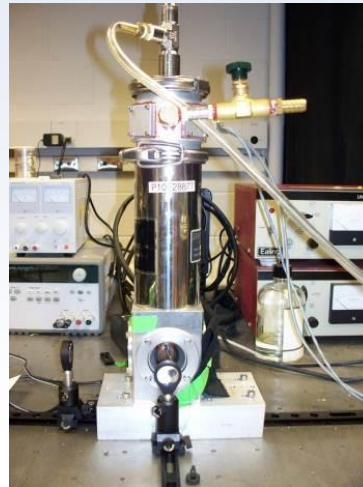
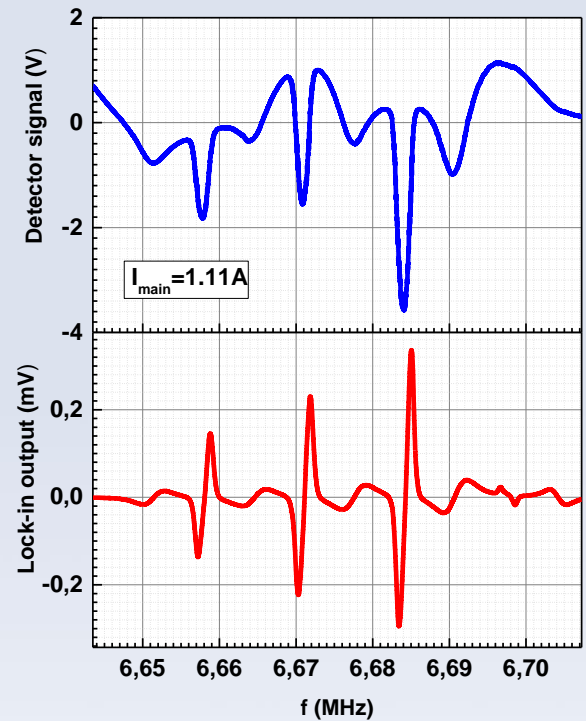

The Experiments

- Condensed Matter (CM)
 - Superconductivity
 - Tunneling in superconductors
 - 2nd sound in ⁴He superfluid

state

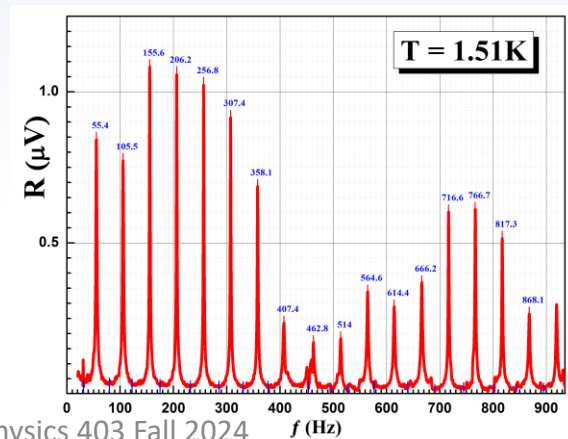
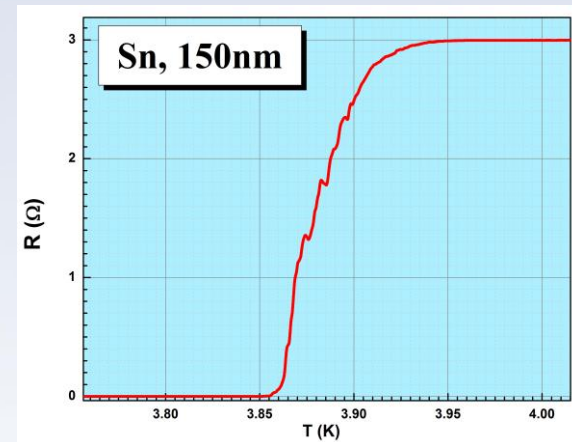
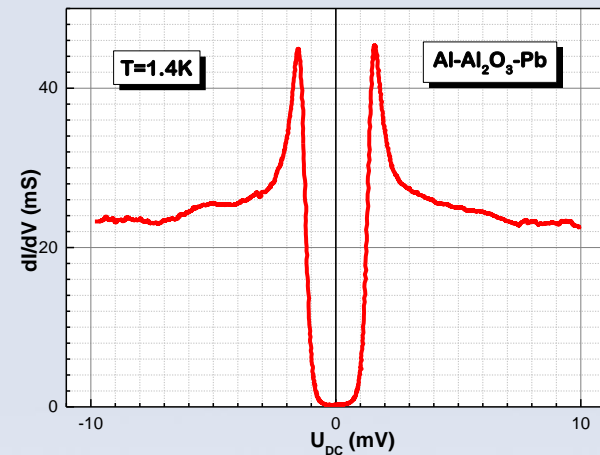

The Experiments

- **Condensed Matter (CM)**
 - Ferroelectrics and ferroelectric phase transition
 - Pulsed NMR
 - Calibration of temperature sensors

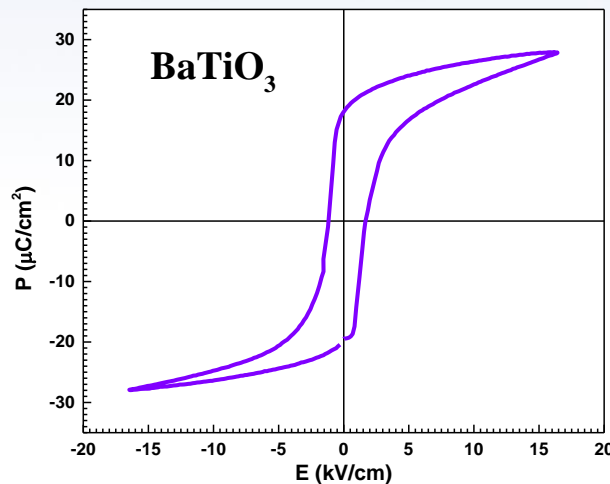
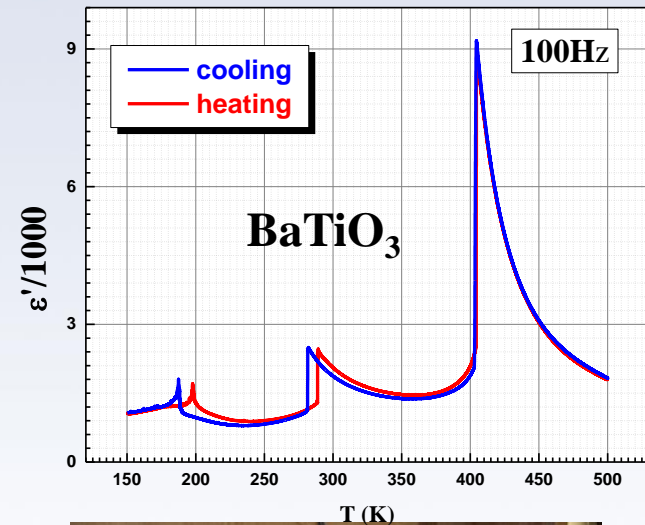
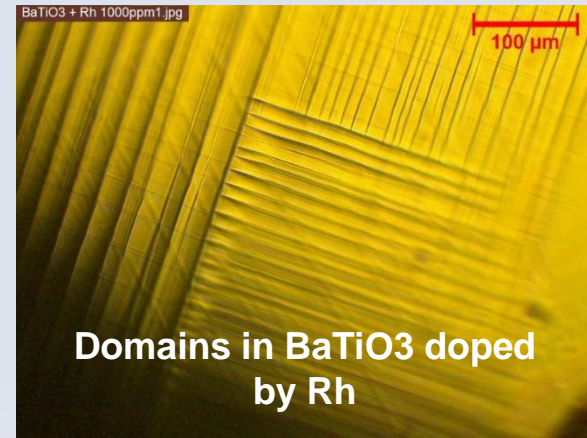

The Experiments

- **Condensed Matter (CM)**
- **Special Tools:**
- **Vacuum film deposition**
- **Atomic Force Microscope**
- **Polarizing microscope**

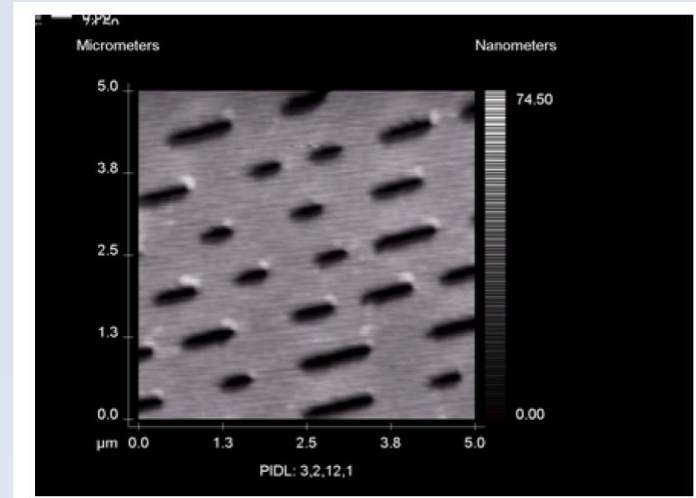

The “manuals”

- Many are just guides
- An only few purchased experiments have “real” manuals
- We serve as your guides ... like real research

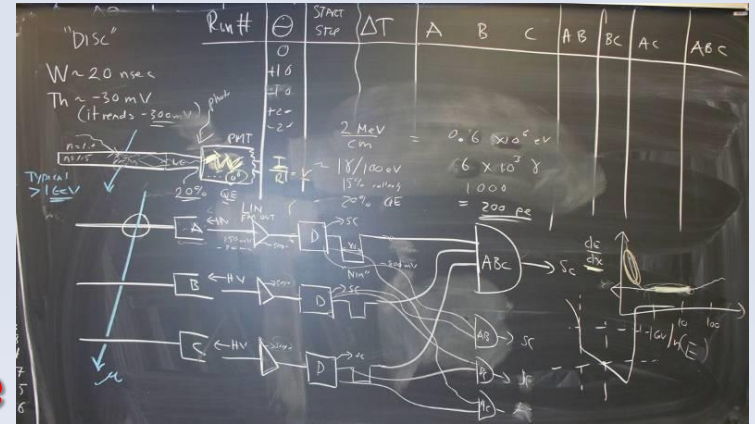

OPTICAL PUMPING OF RUBIDIUM OP1-A

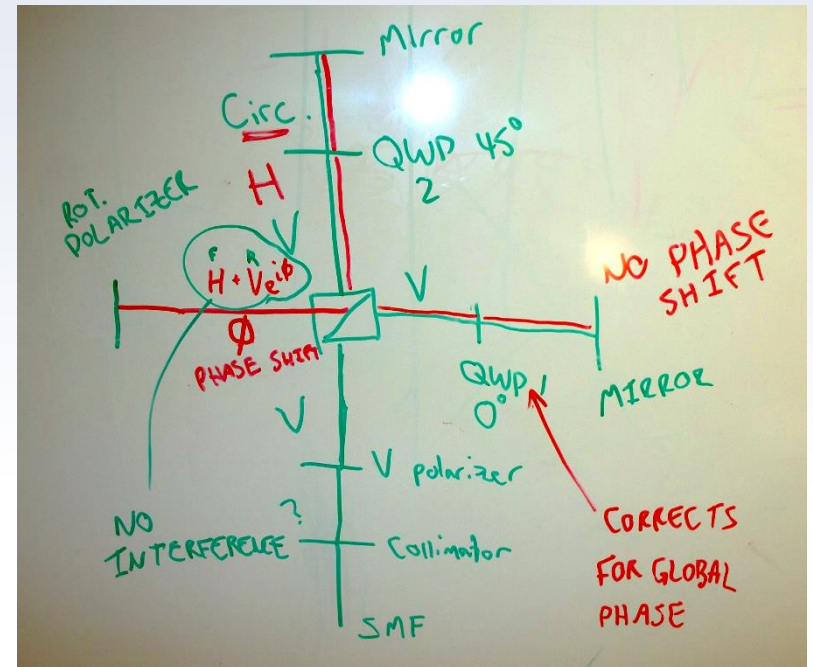

The “manuals”

- For most of the P403 experiments we have prepared the folders containing the most important materials related to the experiment. These folders are located on the shelves in ESB5105. You can borrow the folders until working on experiment and on the report.



Outline

- I. Goals of the course
- II. Teamwork / grades / expectations from you**
- III. Syllabus and schedule
- IV. Your working mode
 - In class and “after hours” access
 - Safety, Responsibility
 - Home and away computing
- V. Take a Lab tour !
- VI. Let’s get started
 - electronic logbooks
 - digital scopes



Grading: Distribution of “740” points

ASSIGNMENT	Points
Expt. documentation: elog reports, shift summaries, plot quality; paper logbooks	120 Total 60 / cycle
Formal reports: physics case, quality of results, depth of analysis, conclusions	400 Total 100 / report
1st Oral report: motivation, organization of presentation; fielding questions	100 Total
Final Oral Presentation \equiv Final Exam	120
Total	740
Effective point total will be	

The grading scale will be a percentage out of “740” :

Letter grading scale is approximately **97% = A+**, **93% = A**, **90% = A-**, **87% = B+**, **83% = B**, **80% = B-**, etc

You can **RESUBMIT one lab report** to improve your grade

(deadline for resubmissions and for report #4 **December 12th 2024**)



Resubmission

You can **RESUBMIT one lab report** to improve your grade
(deadline for resubmissions and for report #4 **December 12th 2024**)

The general rules for resubmission:

1. Original report should be submitted in time with no using of the late ticket
2. The original report should be a real report but not only the title page
3. We do not recommend to resubmit the report if the original grade was over 90 points



Grading: a piece of history and analysis of the results

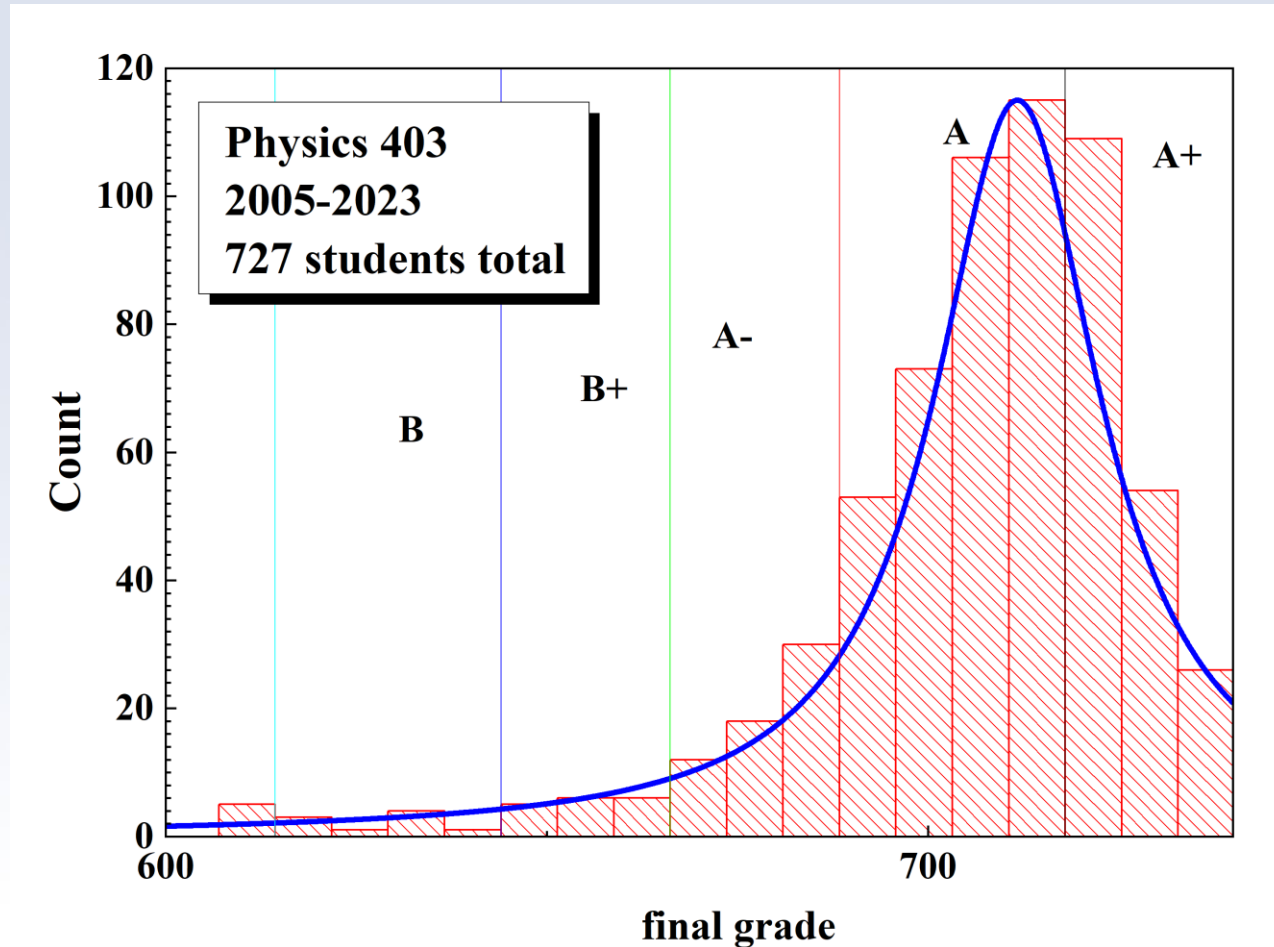

Submission of Lab-Reports

- **Due dates as on syllabus at midnight**
- **The reports should be uploaded to the server:**
- **<https://my.physics.illinois.edu/courses/upload/>**
- **Accepted MS-Word or PDF**
- **For orals – MS-PowerPoint* or PDF**

** preferable*



Absences

- If you are sick, **let Eugene know by email (kolla@Illinois.edu)**. Don't come in and get others sick. We are working side-by-side in a close environment for many hours.
- You can “make up” the time with arrangements and you can have access to the rooms. We will be accommodating.



Absences. Excuse Policy.

- You can be excused from **only one** missed assignment, and only if you **provide medical documentation**.
- If the excused you have **missed the oral presentation** (oral #1), you have to discuss this with us, and we will arrange the date for your oral talk.
- The Final Oral **cannot be excused**, as it is equivalent to a final exam. **You cannot pass the course without credit for this assignment** (see Student Code)

1. Student Code: <https://studentcode.illinois.edu/article1/part5/1-501/>

2. Ibid: <https://studentcode.illinois.edu/article3/part2/3-201/>



Late Reports

- **Policy for late reports**

- You can have **ONE “late ticket”** for a **“free”** delay of up to **3** business days, but you must tell us you are using the ticket
- Reports are due at midnight on the date shown on the syllabus. After that we will charge:
 - 5 points for up to 1 week late. 10 points for up to 2 weeks late.
 - After that, it's too late.



C2-Ex1 (11.13.24)

Outline

- I. Goals of the course
- II. Teamwork / grades / expectations from you
- III. Syllabus and schedule**
- IV. Your working mode
 - In class and “after hours” access
 - Safety, Responsibility
 - Home and away computing
- V. Take a Lab tour !
- VI. Let’s get started
 - electronic logbooks
 - digital scopes



Syllabus

Cycles

	Date	Day	Activity	Comment	Note
1	8/27	Tues	Orientation	About Phy403	
2	8/29	Thurs	Cycle 1-1		
3	9/03	Tues	Cycle 1-2	OriginPro Intro/Root	
4	9/05	Thurs	Cycle 1-3	Elog Comments	
5	9/10	Tues	Cycle 1-4	Error analysis	
6	9/12	Thurs	Cycle 1-5		
7	9/17	Tues	Cycle 1-6	Written Reports	
8	9/19	Thurs	Cycle 1-7		
9	9/24	Tues	Cycle 1-8	Ferroelectricity	C1-Ex1(9.25.24)
10	9/26	Thurs	Cycle 1-9		
11	10/01	Tues	Cycle 1-10	Optical spectroscopy	
12	10/03	Thurs	Cycle 1-11		
13	10/08	Tues	Cycle 1-12	Oral Reports/Talks	
14	10/10	Thurs	Cycle 2-1		
15	10/15	Tues		ORALS 1	
16	10/17	Thurs			
17	10/22	Tues	Cycle 2-2	Lock-in Amps and FT	C1-Ex2 (10.23.24)
18	10/24	Thurs	Cycle 2-3		
19	10/29	Tues	Cycle 2-4	AFM	
20	10/31	Thurs	Cycle 2-5		
21	11/05	Tues	Cycle 2-6	Entanglement	
22	11/07	Thurs	Cycle 2-7		
23	11/12	Tues	Cycle 2-8	High Energy Physics	
24	11/14	Thurs	Cycle 2-9		C2-Ex1 (11.13.24)
25	11/19	Tues	Cycle 2-10	Superconductivity	
26	11/21	Thurs	Cycle 3-11	Cosmology. Final Talks Preparation	
				Thanksgiving Break	
27	12/03	Tues	Cycle 3-12	Journal club	
28	12/05	Thurs		Final Orals #1	
29	12/10	Tues		Final Orals #2	C2-Ex2 (12.12.24)
	12/12	Thurs		READING DAY	



Cycle	#	Experiment
C1-1	1, 16	Second sound
	2, 17	Ferro1
	3, 18	AFM
	4, 19	Ferro3
	5, 20	NMR
	6, 21	Superconductivity
	7, 22	Gamma-gamma
	8, 23	Alpha range
	9, 24	Muons
	10, 25	Mössbauer spectroscopy
	11, 26	Fluorescence
	12, 27	Optical pumping
	13, 28	Quantum optics-1
	14, 29	Quantum optics-2
	15, 30	Quantum optics-3

Cycle	#	Experiment
C1-2	7, 30	Tunneling
	22, 29	Ferro1
	8, 26	Ferro2
	15, 24	Ferro1-2
	13, 14	NMR
	10, 27	Superconductivity
	11, 18	Gamma-gamma
	2, 28	Alpha range
	12, 19	Gamma spectroscopy
	3, 6	Muons
	16, 25	Optical pumping
	9, 17	Fluorescence
	1, 21	Quantum optics1
	4, 20	Quantum optics-2
	5, 23	Quantum optics-3

Assignment of experiments

2 cycles with 2 experiments

→ working with different partners

→ joint team reports and elogs but oral

presentations will be done by each

student personally



Fall 2021 Orals Physics 403

After 2 experiments (1 cycle) we will have oral session. The topic of the presentation will be chosen from the experiments done in this cycle.

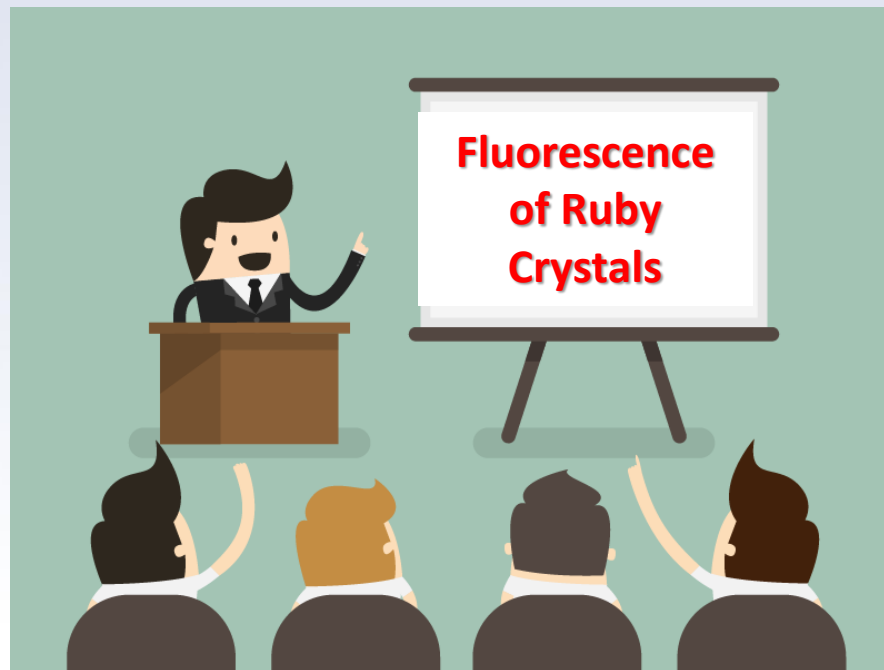

Outline

- I. Goals of the course
- II. Teamwork / grades / expectations from you
- III. Syllabus and schedule
- IV. Your working mode**
 - In class and “after hours” access
 - Safety, Responsibility
 - Home and away computing
- V. Take a Lab tour !
- VI. Let’s get started
 - electronic logbooks
 - digital scopes



Lab Access



Use Your ID Card to Access the Lab

You can access the Lab not only on “Lab days”

Late time rules:

You can stay in the Lab until 8pm but need to work with partner

After 8pm and on weekend days – *you have to discuss this schedule with your instructor* and in general it is preferable to avoid working after 8 pm and on week



Safety is your responsibility !

Hazards: *high voltage, radioactive sources, cryogenics, chemical materials, high pressure*

In class work and “after hours” access & work requires responsible conduct with regards to

- (I) safety/hazards and with
- (II) equipment

Discuss potential hazards at the beginning of each experiment with an instructor or TA

When in doubt stop and ask

Problems after hours: 217 493 1576 (Eugene’s cell)
302 521 2979 (Gina’s cell)



Follow Directly the Recommendations of Safety Working

<https://www.drs.illinois.edu/>

RESEARCH SAFETY

Accident Response ▾ DRS Safety Programs ▾ Training ▾ Waste Management ▾ Safety Library ▾

My Campus User Login

(Material) Safety Data Sheets

Find safety data sheets for material you work with in your lab.

NEWS AND ANNOUNCEMENTS [VIEW ARCHIVE »](#)

Laser Registration and Management
9/23/2018
The Division of Research Safety has added a tool to their website to allow laser users to manage their laser registrations and inventory on-line.

New Tier 1 Select Agent
9/23/2018
As of 9/14/16, the CDC/HHS has added Bacillus cereus Biovar anthracis as a Tier 1 select agent under 42 CFR Part 73.

Laser Safety Eyewear Warning
7/6/2018
Filters not matching specifications on packaging

RESPONSIBILITIES

I work in a lab

I supervise a lab

My work takes me into labs

Follow Directly the Recommendations of Safety Working

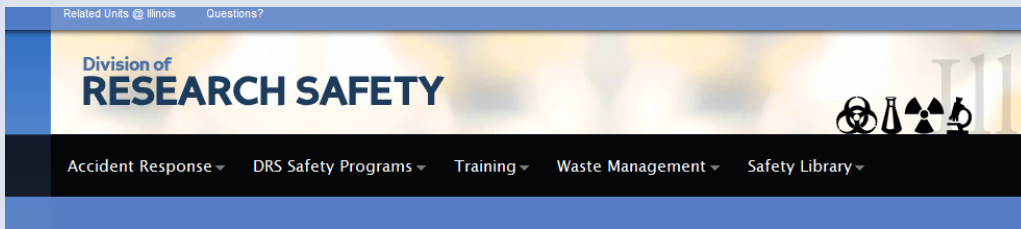

Chemical Waste Collection and Storage

Before generating chemical waste, the researcher should determine how it will be collected and stored and obtain the necessary equipment (containers, labels) in advance. The choice of procedures depends on the type of waste and its final disposition. This section explains how to determine the final disposition of waste, select the appropriate waste container, and store waste in the lab or work area. It also suggests waste minimization strategies.

Determining How to Dispose of a Chemical Waste

The final disposition of a chemical waste is determined by the answers to a series of questions:

- Step 1.** Is the waste [Contaminated Debris](#) (glassware, paper towels, clean-up materials), or is it a chemical or chemical mixture?
If it is contaminated debris: Go to Step 5.
If it is a chemical or chemical mixture: Go to Step 2.
- Step 2.** Is the chemical a DEA (Drug Enforcement Agency) controlled substance? (Refer to the [DEA list controlled substances](#).)
Yes: Refer to the [DEA Controlled Substances Guide](#) for disposal procedures.
No: Go to Step 3.
- Step 3.** Is the chemical a solid (not liquid or gas)?
Yes: Collect and store the waste as described in the waste container and storage guidelines listed below and dispose of it through the Division of Research Safety (DRS) chemical waste disposal program. See the section [Procedures for Requesting Chemical Waste Disposal](#) for the disposal procedures. (No solid chemical waste, hazardous or non-hazardous, should be placed in the regular trash.)
No: Go to Step 4.
- Step 4.** Is the chemical a liquid non-hazardous waste as listed in the section [Liquid Non-Hazardous Chemical Waste Disposal](#)?
Yes: The chemical may be poured down the sanitary sewer (sink drain) with copious amounts of water.
No: Collect and store the waste as described in the waste container and storage guidelines listed below, and dispose of it through the DRS chemical waste disposal program. See the section [Procedures for Requesting Chemical Waste Disposal](#) for the disposal procedures.
- Step 5.** Is the contaminated debris laboratory glassware (broken and unbroken)?
Yes: See the [Laboratory Glassware Waste Disposal](#) section.
No: Go to Step 6.
- Step 6.** Is the debris contaminated with a substance listed in the section [Liquid Non-Hazardous Chemical Waste Disposal](#)?
Yes: The contaminated debris can be disposed of in the regular trash.
No: Collect and store the contaminated debris as described in the waste container and storage guidelines listed below: dispose



Waste container for ethanol, acetone, methanol, isopropanol.



Waste container for mineral spirits.



Waste containers for chemicals used in NMR experiment

Follow Directly the Recommendations of Safety Working

Related Units @ Illinois Questions? Search Go

Division of **RESEARCH SAFETY**

Accident Response ▾ DRS Safety Programs ▾ Training ▾ Waste Management ▾ Safety Library ▾

Profile ▾ Eugene V Colla ▶ Log off

Laboratory Sharps

Definition

Materials that qualify as “sharps” are defined at the state level and shall be disposed of as Potentially Infectious Medical Waste (PIMW). In Illinois, the Illinois Environmental Protection Agency (IEPA) has designated the following material (used or unused) as sharps:

- Any medical needles,
- Syringe barrels (with or without needle),
- Pasteur pipettes (glass),
- Scalpel and razor blades,
- Blood vials,
- Microscope slides and coverslips,
- Glassware contaminated with infectious agents.

NEVER dispose of these items in SDCs:

- Plastic items (except for syringes),
- Beverage containers (no pop cans!),
- Non-biologically contaminated laboratory glassware,
- Solvent/chemical bottles,
- Light bulbs,
- Any paper materials,
- Pipette tips,
- Plastic pipettes,
- Aerosol cans or cans of any type,
- Scintillation vials,
- Any item with liquid (except for blood in vacutainer tubes).



Waste container for sharps



Outline



V. Take a Lab tour !

VI. Let's get started
electronic logbooks
digital scopes



Outline

- I. Goals of the course
- II. Teamwork / grades / expectations from you
- III. Syllabus and schedule
- IV. Your working mode
In class and “after hours” access
Safety, Responsibility
Home and away computing
- V. Take a Lab tour !
- VI. Let's get started**
electronic logbooks
digital scopes



How to record the data

- **Work together**
- **Write down the equipment used**
- **Make a diagram of the setup**
- **Note the settings of dials, switches, gauges**
- **Take a digital photo if appropriate**
- **Use a software drawing program to make a detailed sketch**



How to record the data

- Use the eLog (see next).
- Write down what you did in real sentences.
- Provide enough detail that you can reconstruct later what you did!
- How will you look at the data later?
- Do you have enough information?
- Did the equipment perform as expected?



How to record the data

- Many experiments require you to “change and measure” something by hand
 - Make a **table** in a **paper logbook** or put the data directly into electronic worksheet (*preferable*).
 - Make a “**quick sketch**” of your by plotting the data using OriginPro or other software

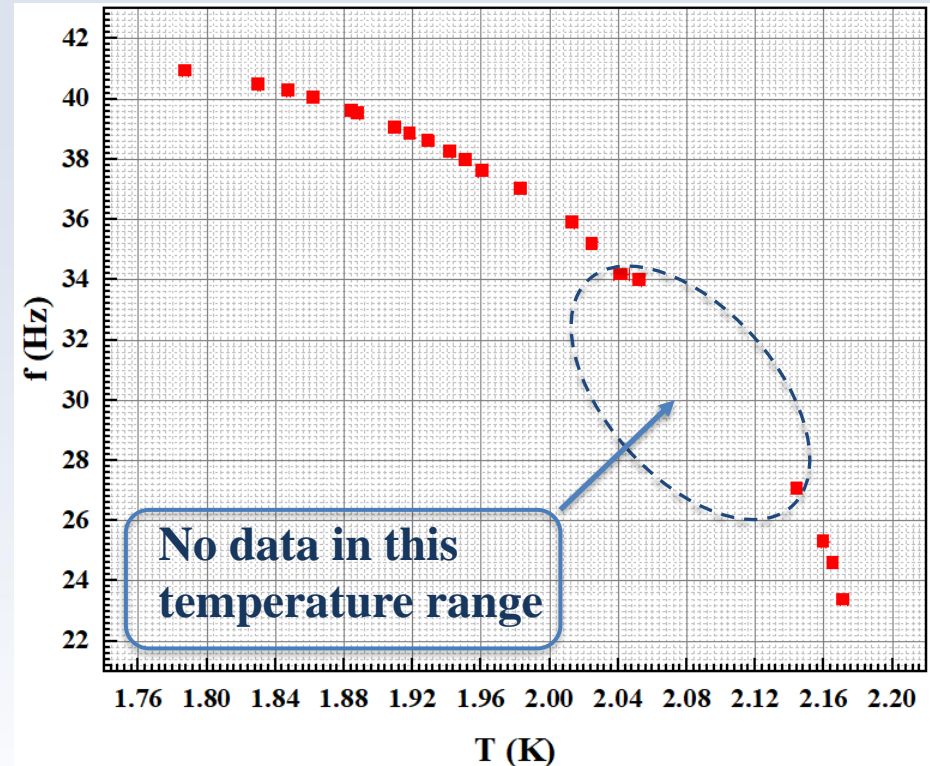

How to record the data

Looking on the graph you can answer the questions:

- Do you have enough points?
- Do you have any obvious anomalies?
- You can repeat points but do not throw them out.
Use other measurements to check reliability

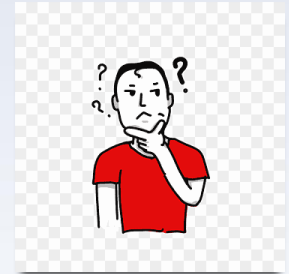
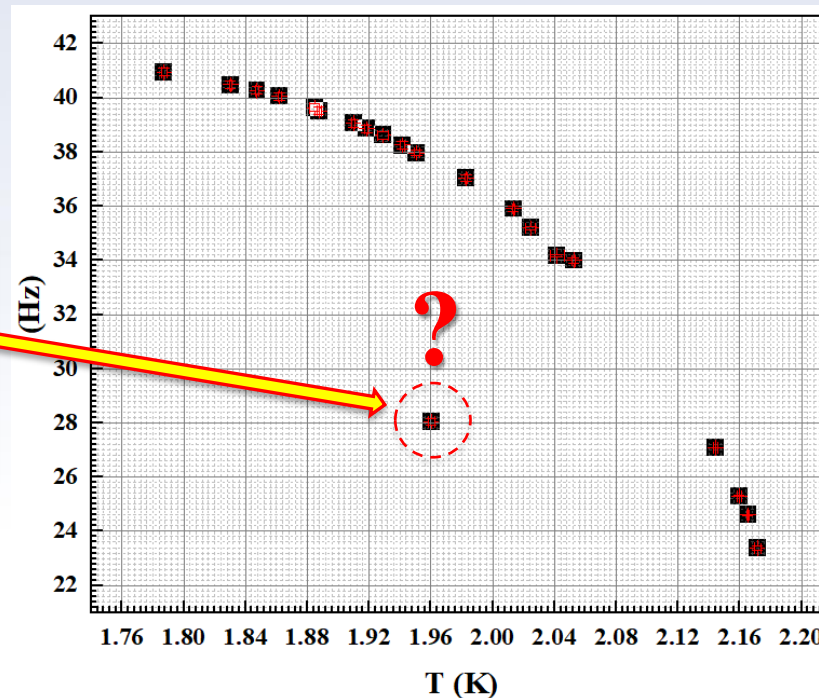

**New physics?
Wrong analysis?
Equipment Problem?**



How to record the data

- Many experiments have built-in, computer-based data

acquisition (DAQ)

- You will not have time to fully understand the DAQ, but

- Be sure you know functionally what it is doing – ask
- A good idea is to make test measurements of something you know



This Photo by Unknown Author is licensed under [CC BY](https://creativecommons.org/licenses/by/4.0/)



Where to exchange, store and retrieve course information.

P403 Lab server

<\\engr-file-03\PHYINST\APL Courses\PHYCS403>



Connecting to the PHYS403 server

Connect to VPN following the instructions on the UIUC VPN website:

<https://techservices.illinois.edu/services/virtual-private-networking-vpn/download-and-set-up-the-vpn-client>

To connect to the PHYS403 Server:

- **Connect to the VPN first, then enter the following as the share to connect to:**
 - **Mac users:** Open Finder: Go: Connect to Server, type in address:
smb://engr-file-03.engr.illinois.edu/PHYINST/APL Courses/PHYCS403
 - **Windows users:** Open Windows Explorer, type in address:
<\\engr-file-03.engr.illinois.edu\PHYINST\APL Courses\PHYCS403>
- **When prompted for username and password, enter:**
“Uofl\[your netID]” and “[your netID password]”



Where to exchange, store and retrieve course information.

(i) Your data, projects, tables etc

\\engr-file-03\PHYINST\APL Courses\PHYCS403

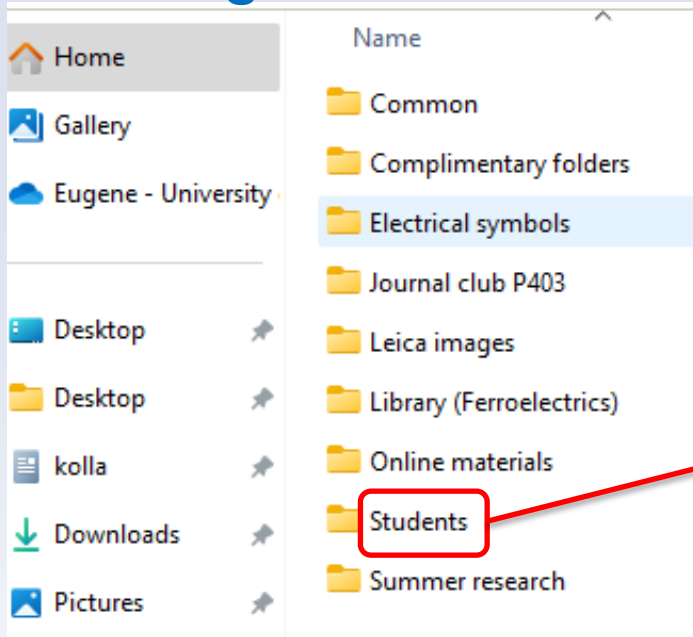

Each student has a folder

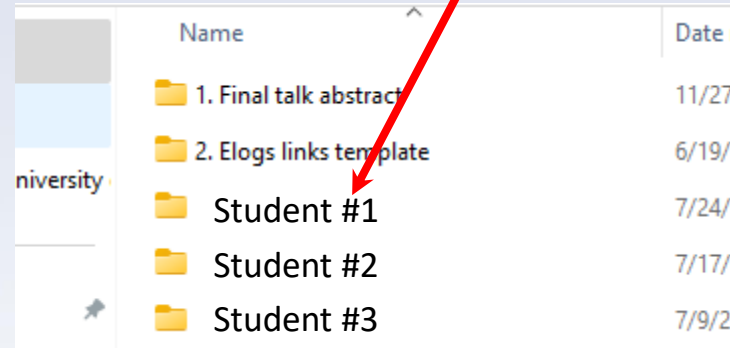

Store all experiment related materials in corresponding folder

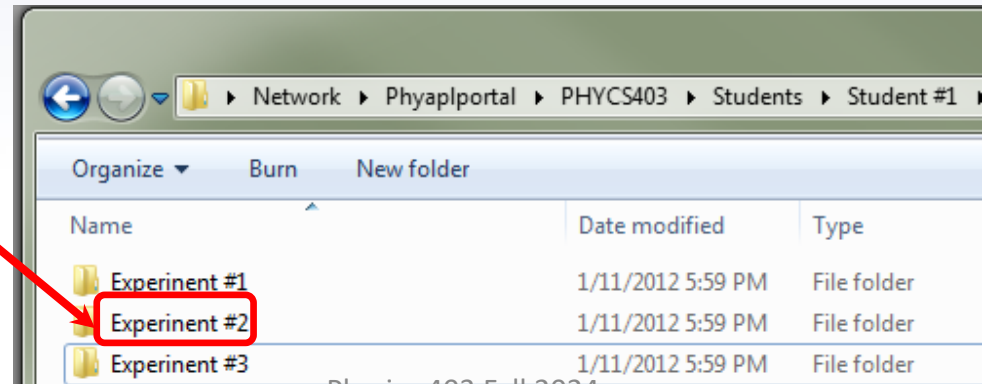

Where to exchange, store and retrieve course information. (i) *Your data, projects, tables etc*

An example of the “smart” structure of folders containing the raw data and data analysis projects

The image displays three screenshots of Windows Explorer windows illustrating a hierarchical folder structure for course data and analysis projects. Blue arrows indicate the flow of the structure from the top-level folders to the specific data and analysis files.

Top-Left Screenshot: Shows the path <code><< Archive >> Fall 2010 Backup</code>. The file list includes folders such as <code>DKDP_run1</code>, <code>DKDP_run2</code>, <code>DKDP_run3 (sample 2 pins 2&5)</code>, <code>DKDP_run4 (sample 1 a-cut)</code>, <code>DKDP_run5(sample 4 c-cut)</code>, <code>DKDP_run6(sample 4 c-cut)</code>, <code>DKDP_run7(sample 4 c-cut)</code>, <code>DKDP_run8(sample 4 c-cut)</code>, <code>DKDP DC bias runs (Eugene)</code>, and <code>DKDP run 8 250V and diff rates (eugene)</code>.

Top-Right Screenshot: Shows the path <code>Network > Phyapportal > PHYCS403 > Students > Student #1</code>. The file list includes folders <code>Experinent #1</code>, <code>Experinent #2</code>, and <code>Experinent #3</code>. The name 'Experinent #1' is highlighted with a red box.

Bottom-Right Screenshot: Shows the path <code><< Students >> Archive >> Fall 2010 Backup</code>. The file list includes folders <code>Lab3Ferroelectrics</code> and <code>Data_Analysis</code>, and files <code>e' vs T #1.OTP</code>, <code>Temperature Profile</code>, <code>Temperature_Profile</code>, and <code>temperatureProfile</code>. The folder 'Lab3Ferroelectrics' is highlighted with a red box.

Blue arrows indicate the flow of the structure: from the 'Students' folder in the top-right screenshot to the 'Lab3Ferroelectrics' folder in the bottom-right screenshot, and from the 'Lab3Ferroelectrics' folder to the 'DKDP_run' folders in the top-left screenshot.

Where to retrieve course information.

Manuals, papers, setup diagrams and other useful materials

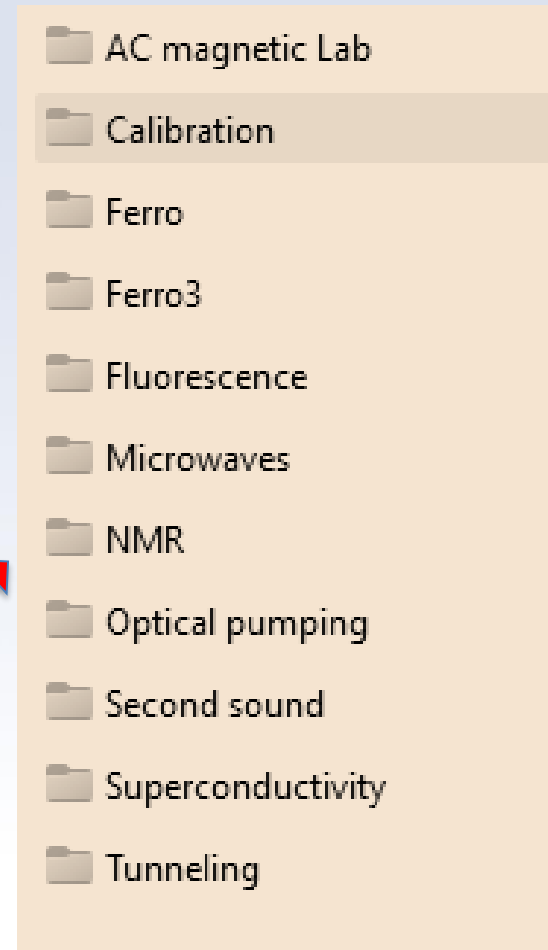
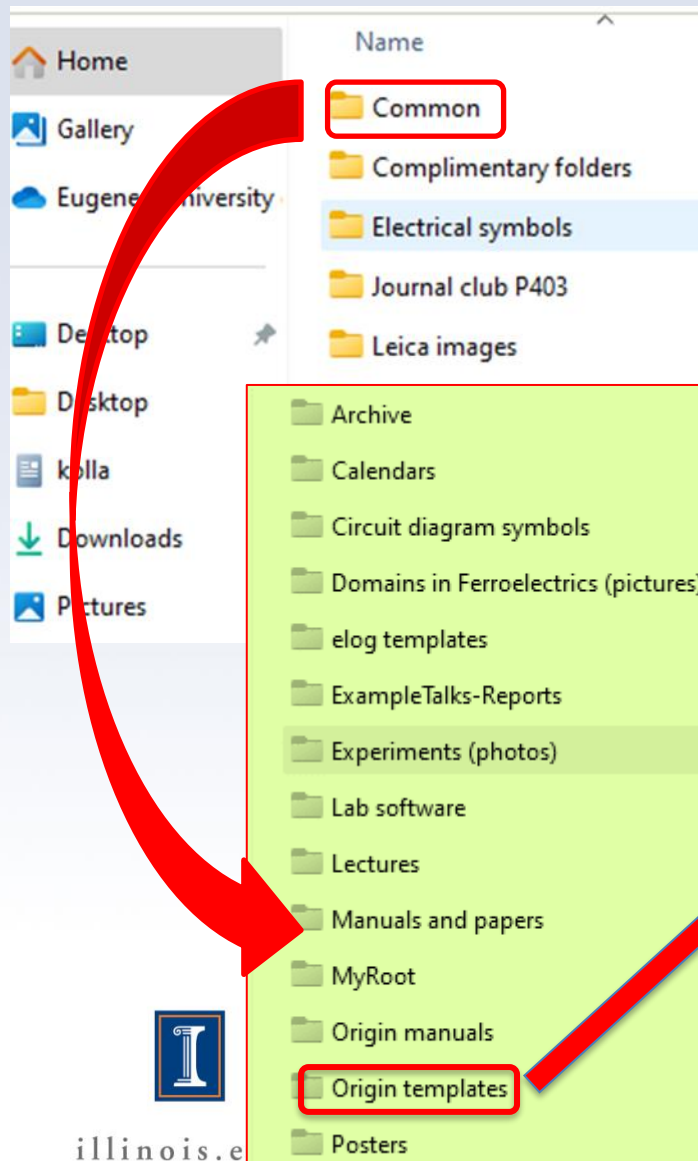

Where to retrieve course information.

Origin templates

Common



Origin templates



- Optical pumping
- Second sound
- Superconductivity
- Tunneling

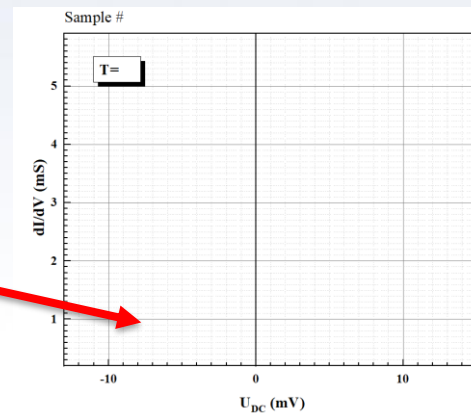
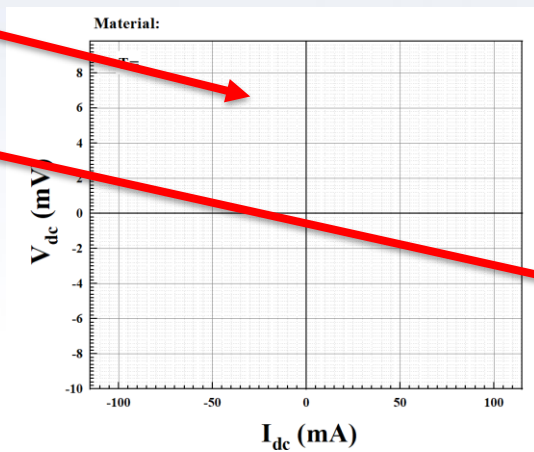
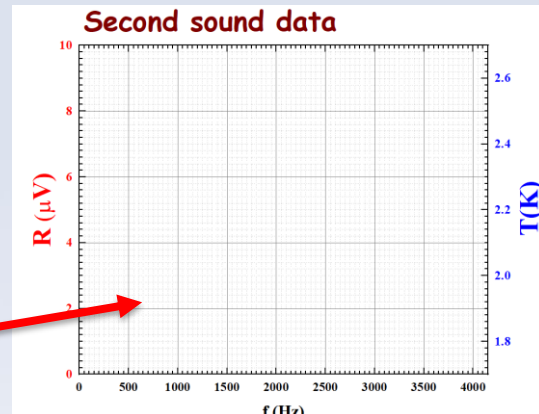
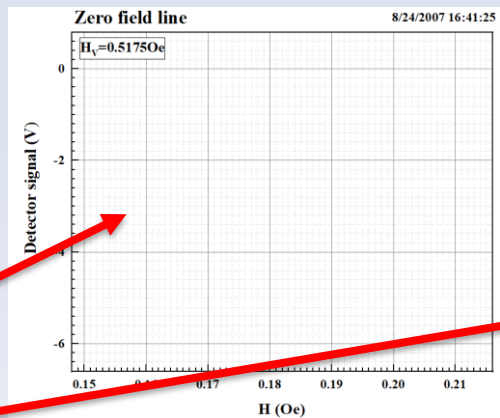

Where to retrieve course information.

Material Prepared for Online Teaching

- Common
- Complimentary folders
- Electrical symbols
- Journal club P403
- Leica images
- Library (Ferroelectrics)
- Online materials

- Alpha Range
- Ferro1
- Ferro2
- Ferro3
- Fluorescence
- gamma spectroscopy
- gamma-gamma
- Inroduction (videos)
- Moessbauer
- Muon Lifetime

- Dielectric data
- Equipment manuals
- Reading materials
- Setup
- Setup picturtes

- ZFC experiment (papers)
- 1998_Book_FerroelectricPhenomenalInCr...
- Ferro2 experiment.docx
- Ferro2 experiment2.docx
- Polarized Light Microscopy.pdf
- Shur_FAST POLARIZATION REVERSAL.pdf



Where to retrieve course information.

- Common
- Complimentary folders
- Electrical symbols
- Journal club P403
- Leica images
- Library (Ferroelectrics)
- Online materials**

Material Prepared for Online Teaching

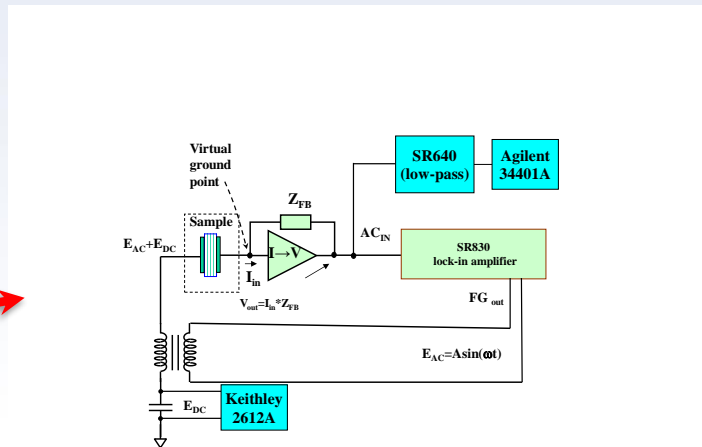
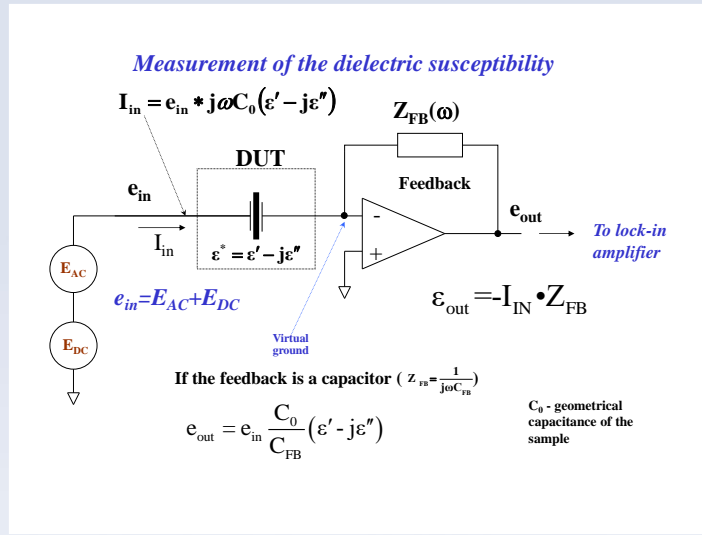

- Ferro1
- Setup**



Where to retrieve course information.

- Common
- Complimentary folders
- Electrical symbols
- Journal club P403
- Leica images
- Library (Ferroelectrics)
- Online materials

Material Prepared for Online Teaching

- Polarizer
- Half-wave plate (HWP)
- Quarter-wave plate (QWP)
- Beam block
- BiBO crystals
- 405 nm laser
- Quartz slab
- 810 nm filter
- Fiber collimation package
- Avalanche photodiode (APD)
- Optical fiber

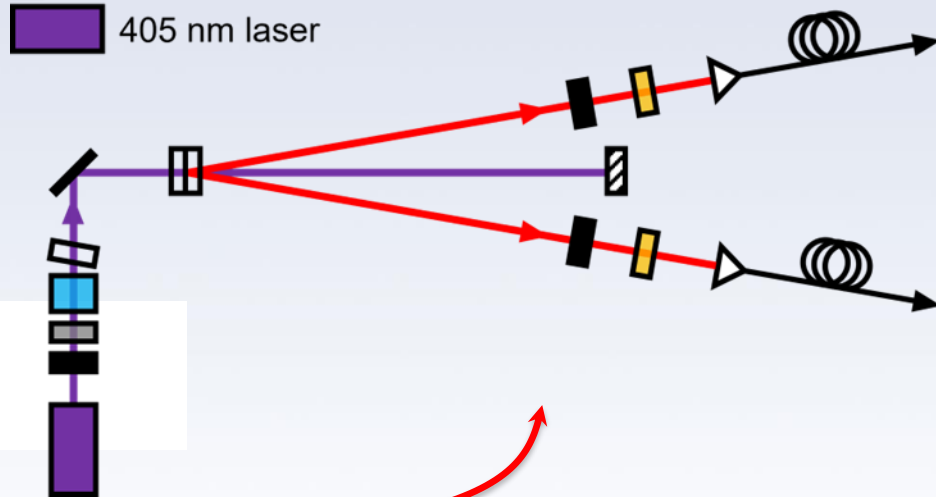
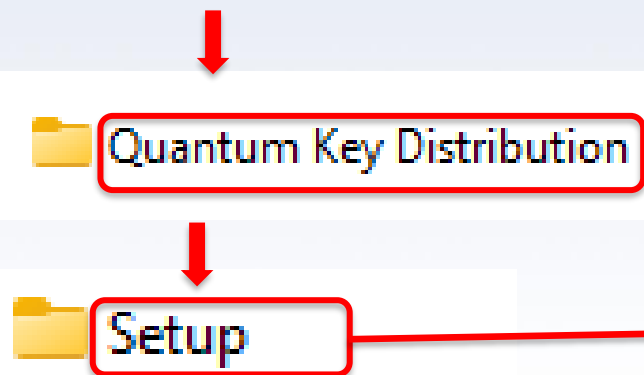

“Journal club”

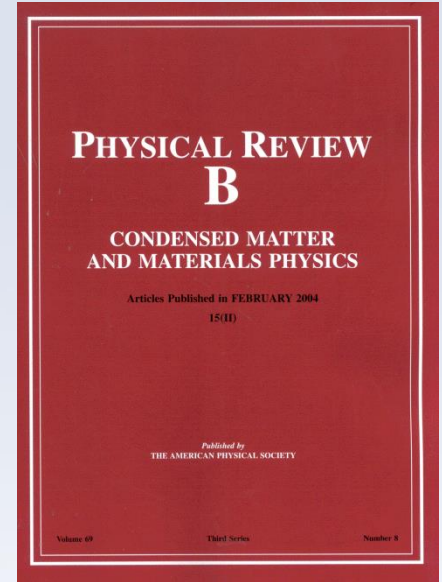
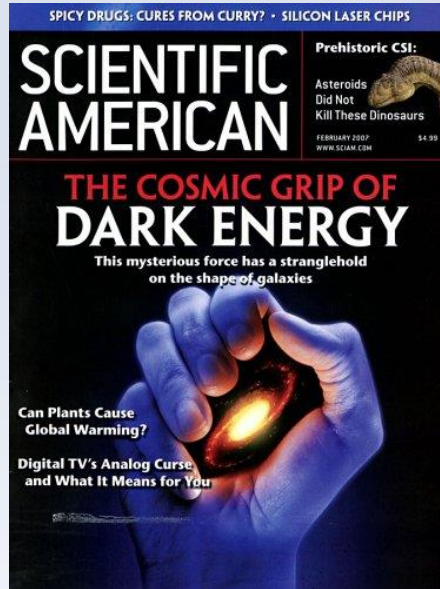
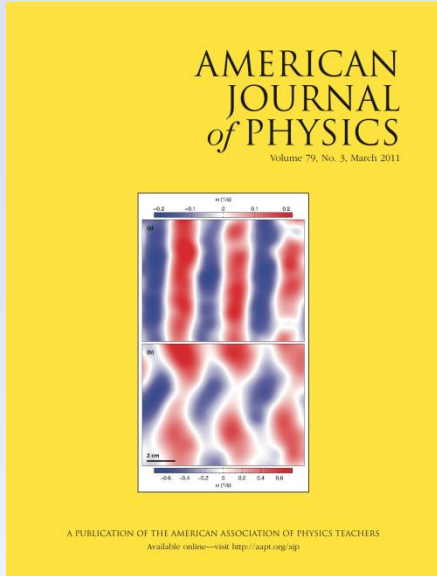

<http://ajp.aapt.org/#mainWithRight>

<http://www.nature.com/nature/index.htm>

<http://www.scientificamerican.com/>

<http://www.sciencemag.org/journals>

<http://publish.aps.org> or <http://prola.aps.org/>



“Journal club”

Walking with Coffee: Why Does it Spill?

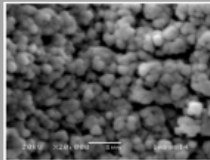

Growth of Diamond Films from Tequila

J. Morales^{1,2}, L. M. Apátiga², V. M. Castaño²

1. Facultad de Ciencias Físico Matemáticas, Universidad Autónoma de Nuevo León
2. Centro de física Aplicada y Tecnología Avanzada, Universidad Nacional Autónoma de México

Fabrication and Characterization of Ultrathin Three-Dimensional Thermal Cloak

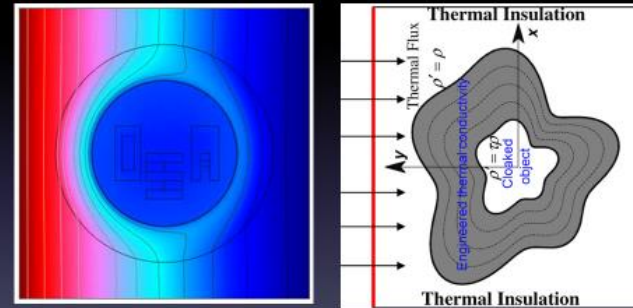

(Credit: Guennea)

Student #1

University of Illinois at Urbana-Champaign

The Physics of Beer Tapping

PRESENTATION BY JOSEPH MIRABELLI

JAVIER RODRÍGUEZ-RODRÍGUEZ, 1,* ALMUDENA CASADO-CHACÓN, AND DANIEL FUSTER

1 FLUID MECHANICS GROUP, CARLOS III UNIVERSITY OF MADRID

2 CNRS, UNIVERSITÉ PIERRE ET MARIE CURIE



“Journal club”

Journal Access

If you cannot access journal papers using VPN, go to UIUC’s library proxy test site and enter the address of the paper you want to read:

<http://www.library.illinois.edu/proxy/test/>

Recommended journal websites

- **American Physical Society Journals:** <https://journals.aps.org/about>
- **Nature:** <http://www.nature.com/nature/index.html>
- **Science:** <http://www.sciencemag.org/journals>
- **American Journal of Physics:** <http://scitation.aip.org/content/aapt/journal/ajp>



Entering the e-Log ...

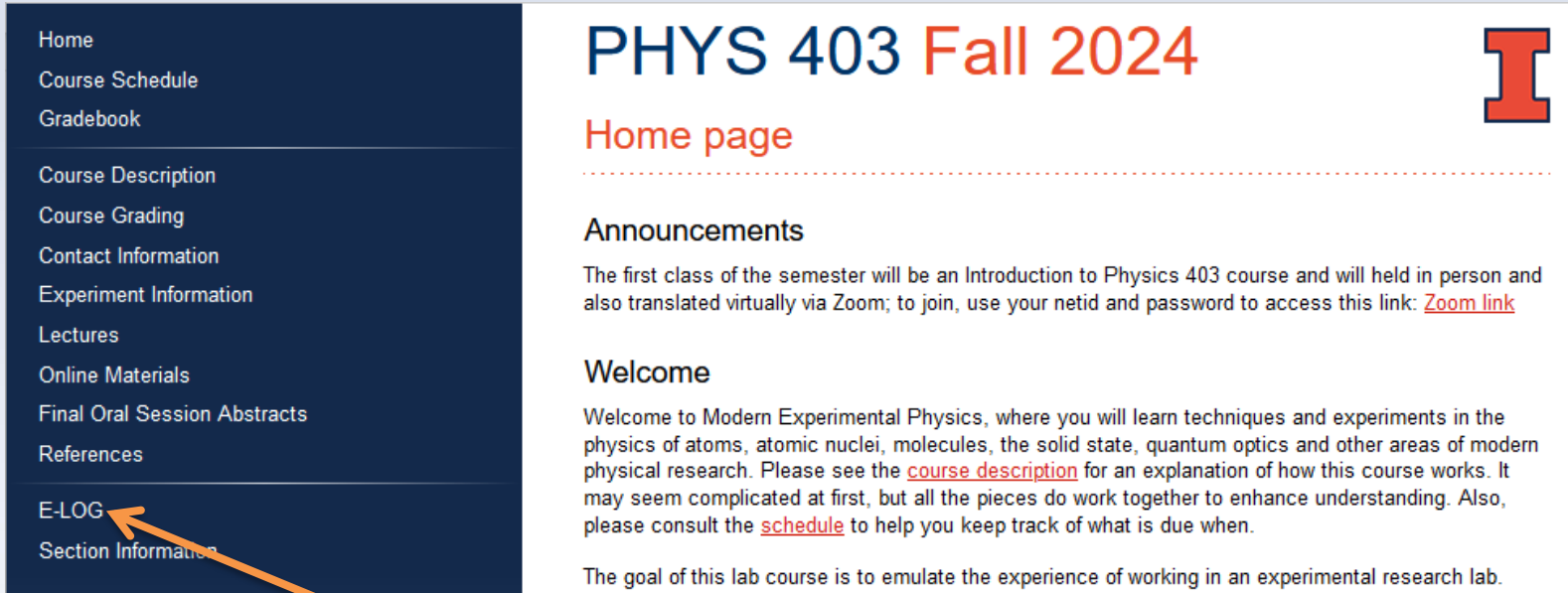

Home
Course Schedule
Gradebook

Course Description
Course Grading
Contact Information
Experiment Information
Lectures
Online Materials
Final Oral Session Abstracts
References

E-LOG

Section Information

PHYS 403 Fall 2024



Home page

Announcements

The first class of the semester will be an Introduction to Physics 403 course and will held in person and also translated virtually via Zoom; to join, use your netid and password to access this link: [Zoom link](#)

Welcome

Welcome to Modern Experimental Physics, where you will learn techniques and experiments in the physics of atoms, atomic nuclei, molecules, the solid state, quantum optics and other areas of modern physical research. Please see the [course description](#) for an explanation of how this course works. It may seem complicated at first, but all the pieces do work together to enhance understanding. Also, please consult the [schedule](#) to help you keep track of what is due when.

The goal of this lab course is to emulate the experience of working in an experimental research lab.

Link to e-Log



Entering the e-Log ...

**Use your University
Username and
Password**

Please Sign In

Illinois Login

Or login as a guest



Entering the e-Log ...

ELOGS

[View Books](#) [View Logs](#)

Fall 2024 eLog Book

Your eLog Books

Physics 401 Fall 2024	burkova	5/13/2024 11:56:07 AM
Physics 403 Fall 2024	rwiltfon	5/29/2024 9:28:40 PM
Physics 403 Summer 2024	rwiltfon	5/29/2024 9:27:39 PM



Entering the e-Log ...

[View all Physics 403 Fall 2022 logs]

Editing log: Welcome

Entry time	8/22/2022 2:41:05 PM	First author	Eugene Colla
Second author	<input type="text" value="Start typing name, select netID"/>	Third author	<input type="text" value="Start typing name, select netID"/>
Experiment	<input type="text" value="General post"/>	Post type	<input type="text" value="Other"/>

Subject

Text

Source

Format **B** *I* U ~~S~~ x_2 x^e I_x

Dear Students,

Welcome to Modern Physics Lab Course!



e-logs: Making a post ...

- To create a new post, click 
- Fill in the *Author, Experiment, Post Type, and Subject.*

Don't forget to enter the name of the **second author**

Entry time	6/7/2021 4:26:47 PM	First author	Eugene Colla
Second author	<input type="text" value="Student no2"/>	Third author	<input type="text" value="Start typing name, select netID"/>
Experiment	<input type="text" value="Ferro1"/>	Post type	<input type="text" value="Setup"/>
	<input type="button" value="Load Template"/>		
Subject	<input type="text" value="First day record"/>		



e-Log . Using *Templates*

Experiment



Templates are not “ready to go” eLog records. There are some suggestions and comments which you need to read, accept/decline and remove from the final version of the eLog record.

Choose a template

The template you chose will be inserted after any text you may already have in your log.

Available templates

Material		Sample ID		Sample area: ... mm ²		Sample thickness: ... mm
File name	Folder	T range (K)	Frequency (Hz)	V _{AC} (V)	V _{DC} (V)	Comments

In Comments you have to provide the id of the experiment. This is only template related to the



e-logs: First a brief tour

How to use it

- **Pause and summarize your work at natural stopping points in the action. This is useful for particular findings and measurement sequences.**
- **Along the way, save data, plots, scope shots to your folder on the server.**
- **Near the end of the class, add a summary/conclusion, indicate future directions, and make sure the e-log provides a rather complete overview of the highlights of your work. Upload your plots, scope shots, etc. and describe the data.**

Some General Physics 403 Rules.



No cellphones or computer activities during the talks, presentations and discussion (except the cases when it is necessary)



Some General Physics 403 Rules.



No Food or Drinks in Lab except ESB 5105

